

## MODELS

FULL BLACK



Sunbrella  
Black

RAL 9005  
Black

ARCHITECTURE



Sunbrella  
Marble

RAL 9018  
Papyrus  
white

## DIMENSIONS

### NANO UX

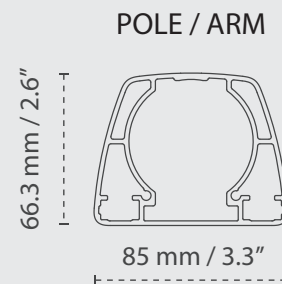
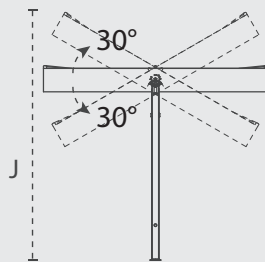
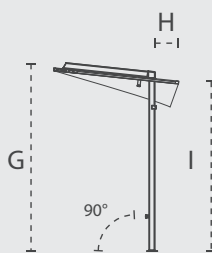
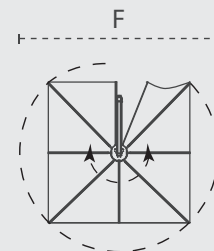
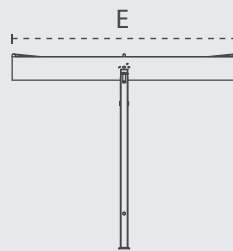
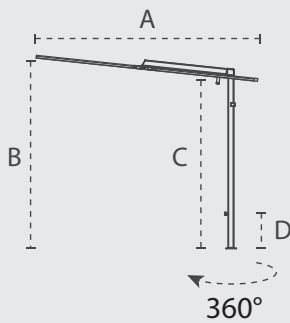

+/- 2% Tolerance	A cm/ft	B cm/ft	C cm/ft	D cm/ft	E cm/ft	F cm/ft	G cm/ft	H cm/inch	I cm/ft	J cm/ft
2.5m/8' 2"	250/8' 2"	210/7' 2.6"	190/6' 2.8"	39/1' 3.4"	250/8' 2.4"	355/11' 7.8"	210/6' 10.7"	30/ 11.8"	190/6' 2.8"	265/8' 8.3"

## DIMENSIONS BASE AND BASEBLATE (MM/FT)

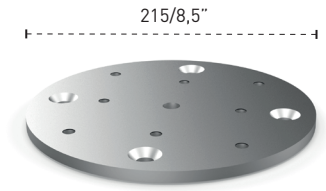
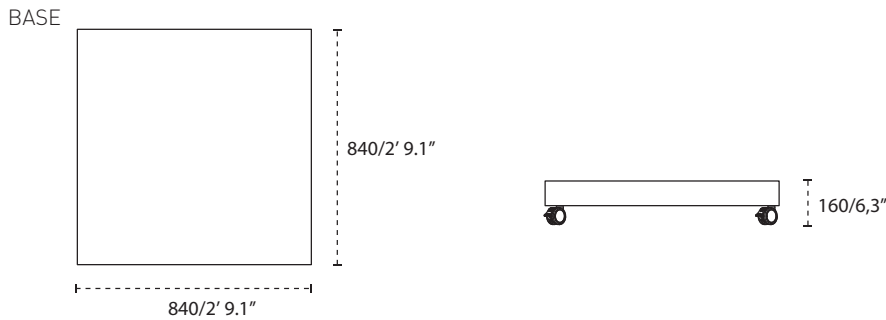

Baseplate for installation on a hard surface and combined with an anchorage on a soft surface.

## MATERIALS

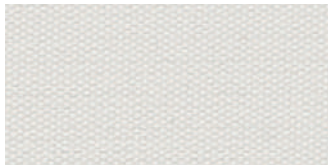

### FABRIC

Sunbrella – 100% Acryl 260 gr/m<sup>2</sup>  
More details – see spec sheet Fabrics



### RIBS

Aluminum ribs



### POLE, ARM AND HANDLES

Aluminum powder coated RAL 9005  
Black or RAL 9018 Papyrus White

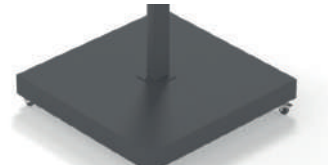

### BASE

Base: hot dip galvanized steel  
Cover: Aluminum Powder coated RAL 9005 or RAL 9018

## PACKAGING & TRANSPORT

NANO UX	L (cm)	W (cm)	H (cm)	Weight (kg)	L (ft)	W (inch)	H (inch)	Weight (lbs)
Umbrella box	205	30	15	25	6' 8.7"	11.8"	5.5"	55
Base+Base cover	90	90	10	15	2' 11.4"	2' 11.4"	3.9"	33

## NICE TO KNOW

- Spare parts available
- Designed and manufactured in Belgium
- Warranty between 10 and 2 years, please consult our warranty policy at [www.umbrosa.com](http://www.umbrosa.com)
- Download owner's manual (QR-code included), also available at [www.umbrosa.com](http://www.umbrosa.com)
- Storage bag included (Sunbrella Flanelle)
- Wind speeds up to 5 beaufort, 30 km/h, 18 mph when base is permanently fixed
- Tested at TU Delft

## SAFETY STATEMENTS & WARNINGS

- Product is suitable for light wind and/or light rain only.
- Position product in direction of wind as recommended in user manual.
- Do not use product in inclement weather, such as strong wind, thunderstorms, heavy rain or snow, and make sure that the umbrella is closed and stored in advance.
- Never allow the umbrella to flap in the wind. This could cause personal injury, damage to personal property, damage to umbrella and/or umbrella canopy.
- Close product and secure strap when not in use.
- Do not use product without its base or unless attached to building structure, and keep umbrella secured to umbrella base or mount at all times.
- Do not use product over or near harsh chemicals or open flames.
- Place product on stable and level surface.
- Do not allow children to assemble or operate product.
- Do not leave product unattended.
- Store product indoors during winter and extreme weather conditions.
- When adjusting or assembling the umbrella or umbrella base, make sure fingers, toes or any other parts of the body are clear from moving parts. Failing to do so may result in serious injury.
- Only use Umbrosa replacement parts.
- Read owner's manual.
- Any modifications to the product or failure to follow recommended care will void the warranty.
- Wind damage is not covered under our limited warranty.

The content of this document, in particular the mentioned models, is protected by copyrights and/or design rights. The present document and its content is communicated to you for information purposes only. Any partial or total reproduction or any other use without our prior written permission is strictly prohibited. This technical sheet remains subject to possible changes. Of course we do our best to eliminate all mistakes, but Umbrosa is not responsible for the errors in the documentation of products. All measurements are approximate and are provided for informational purposes only.